

*PODS (Duo, Small Team & Large Team)*  
**FABRIC REAR WALL  
SAFETY AND INSTALLATION  
INSTRUCTIONS**



## Oasis Berco Installation, Operating & Safety Instructions

### Linear & Soft Pod, Booth and Hub

- All Oasis Berco products are intended for commercial use.
- Please note that specific installation drawings and instructions are provided at the end of this document.
- **WARNING** Risk of injury – Maximum Load on Table Surface is 200 pounds evenly distributed
- **DRY LOCATIONS ONLY**

#### IMPORTANT SAFETY INSTRUCTIONS

When using an electrical furnishing, basic precautions should always be followed, including the following: Read all instructions before using this Oasis Berco furnishing.

**DANGER** – To reduce the risk of electric shock:

1. Always unplug this furnishing from the electrical outlet before cleaning.

**WARNING** – To reduce the risk of burns, fire, electric shock, or injury to persons:

1. Unplug from outlet before putting on or taking off parts.
2. Close supervision is necessary when this furnishing is used by, or near children, invalids, or disabled persons.
3. Use this furnishing only for its intended use as described in these instructions. Do not use attachments not recommended by the manufacturer.
4. Never operate this furnishing if it has a damaged cord or plug, if it is not working properly, if it has been dropped or damaged, or dropped into water. Return the furnishing to a service center for examination and repair.
5. Keep the cord away from heated surfaces.
6. Never operate the furnishing with the air openings blocked. Keep the air openings free of lint, hair, and the like.
7. Never drop or insert any object into any opening.
8. Do not use outdoors.
9. Do not operate where aerosol (spray) products are being used or where oxygen is being administered.
10. **WARNING: Risk of Electric Shock** – Connect this furnishing to a properly grounded outlet only. See Grounding Instructions below.
11. For loading always put heavier items at the bottom and not near the top in order to help prevent the possibility of the furnishing tipping over.
12. **WARNING** Risk of injury – Maximum Load on Table Work Surface is 200 pounds evenly distributed.

SAVE THESE INSTRUCTIONS

## GROUNDING INSTRUCTIONS

This product is for use on a nominal 120-volt circuit and has a grounding plug that looks like the plug illustrated in the sketch below. Make sure that the product is connected to an outlet having the same configuration as the plug. No adapter should be used with this product.

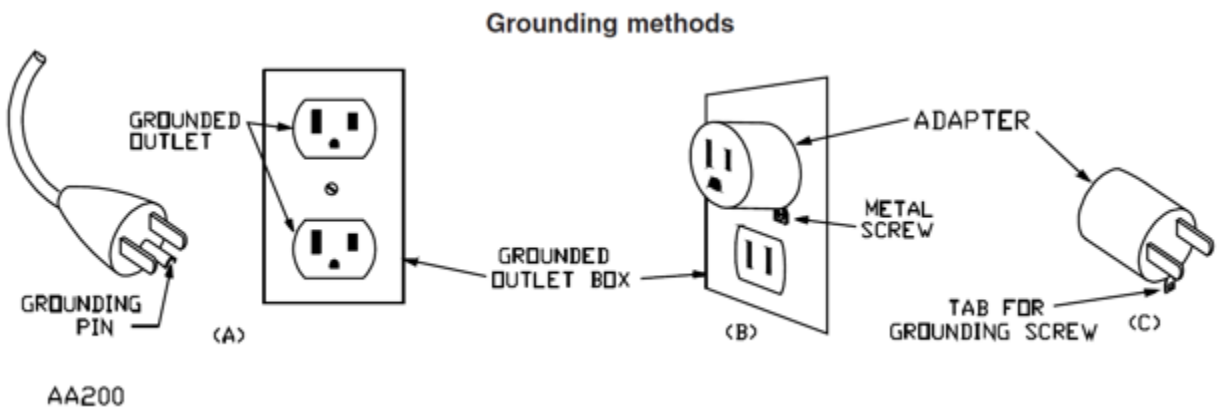

AA200

## Tools needed for assembly:

- #2 Phillips Bit/Screwdriver
- Torx – 30 driver bit
- 3.5MM Allen Wrench
- Utility Knife
- Lint Roller
- White Gloves

## Hardware/Accessory Kit:

- 18 – 1/4-20 x 2" machine screws
- 6 - #8 x 2 1/2" self tapping screws
- 8 - #8 x 1 1/2" wood screws
- 4 - #8 x 3/4" wood screws
- Double Handle Glass Suction Cups – 2 per order
- Glass Door Handle
- Glazing Seal
- "V" Seal
- Alcohol wipes

## Before you start:

1. Read instructions and check that all parts are accounted for before you start building.
2. Begin assembly as close to final product location as possible.
3. Additional assembly instructions may be required depending on specification of product ordered.
4. Read all Operating & Safety instructions before using this Oasis Berco furnishing.

## Step 1



- A. White gloves are recommended during installation to avoid dirt or grease transfer to the Oasis unit.
- B. Start assembly by attaching the rear left wall and corner post using 4 – 1/4 -20 x 2" machine screws from the hardware kit.
- C. Use Allen wrench to adjust the glides in the base rails to make sure the panel is level.



## Step 2

- A. Attach the left hand wall using  $4 - \frac{1}{4} - 20 \times 2''$  machine screws. If the power exits this side of the Pod, use the panel with the grommet at the bottom.
- B. Remove adhesive strip from T-Mold on outside of rear panel before joining together.
- C. Connect the second rear wall panel using  $4 - \frac{1}{4} - 20 \times 2''$  machine screws into pre-installed metal inserts.



## Step 3

- A. Repeat the process for the right side.
- B. Attach the right wall to the corner post using  $4 - \frac{1}{4} - 20 \times 2''$  machine screws.
- C. Use Allen wrench to adjust the glides in the base rails to make sure all panels are level.

## Step 4



- A. The front glazed wall/door assembly will be supplied knocked down.
- B. The parts you need include: left post, right post, base rail and top rail.

## Step 5



- A. Secure the base rail (threshold) to the posts first using 4 - #8 x 2 1/2" self tapping screws. The radius portion of the post should be facing outside the Pod.
- B. Secure the top rail to the posts using 2 - #8 x 2 1/2" self tapping screws. The flat face of the top rail should be facing the outside of the Pod.
- C. Secure header angle brackets to side posts using 2 - 1/4 - 20 x 2" screws.

## Step 6

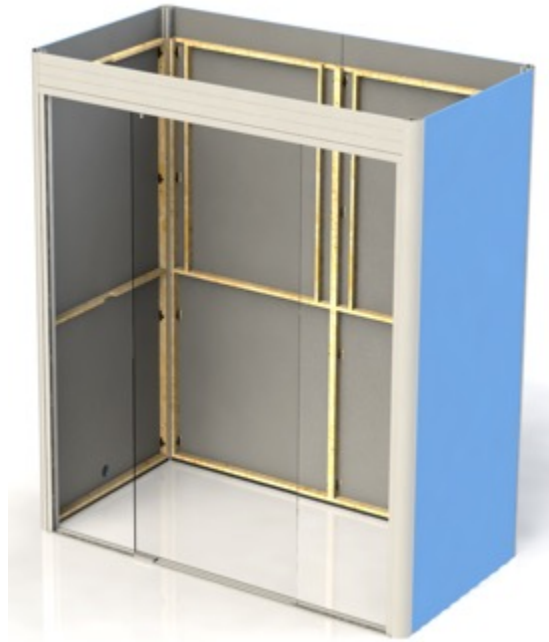

- A. Make sure the structure is square and all panels line up with the top posts and frame headers. Tighten all bolts once all is square.
- B. Install the door side glass panels into position. ***Be careful not to set the glass on a corner or it will chip or break.***
  - i. Lift the left side glass panel into the top groove and then set down into the base groove. (Use double handle glass suction cups provided.)
  - ii. Repeat for the right side glass panel.
  - iii. Push the side glass panels in towards the hinge plates and door stop where the door glass will be installed (Step 11).
- C. Push the glazing seal (see picture below) around the top and sides to secure the panels in place. You will need to cut seal to correct length. This gasket is push in place and will form a tight seal to hold the glass panel.

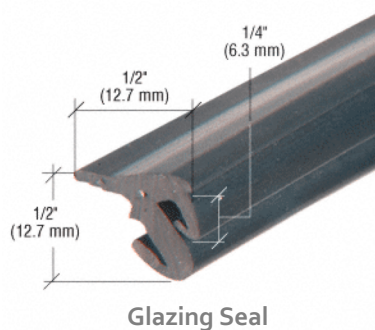

## Step 7

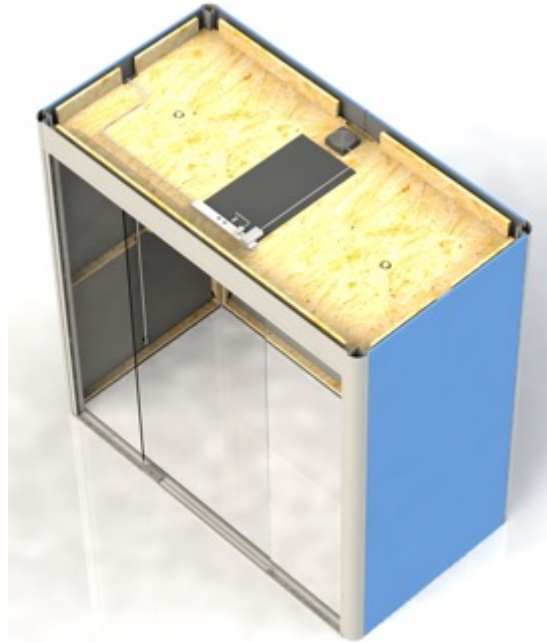

- A. The ceiling panel is supplied with the electrical pre-installed.
- B. Lift the ceiling panel into position from the top with the fan unit to the rear of the Pod. Before you set it in place, make sure the cords mentioned in "C" and "D" below are hanging into the unit.
- C. Drop the power cable down the inside of the booth and through the cable outlet so it exits out the base of the unit. The power cord can run down the left or the right side of the unit.
- D. Drop the motion sensor down the front corner of the booth closest to the hinge side of the door. This will be attached after the acoustical panels are installed.
- E. If optional sofas include integrated power, drop an extension cord down the inside of the booth wall(s). The extension cord(s) will be connected to the sofa later in the installation.
- F. Connect the power and make sure the light & fan turn off/on via the sensor (the light intensity and fan speed can be changed by adjusting the dials on the ceiling panel).
  - i. If the light and fan do not work, first check all connections on the ceiling panel.
  - ii. Reset the motion sensor (See Step 10, E).
  - iii. See Electrical Troubleshoot section at the end of this document.
  - iv. If all connections are secure, please contact Oasis Berco at 888-772-4788 and ask for Dave Dunn or James Holborow in Engineering.
- G. Secure the ceiling panel using 8 - #8 x 1 1/2" wood screws from the hardware kit. Evenly space 2 screws on each of the 4 walls and screw up from the inside of the Pod into the ceiling to secure in place.



## Step 8

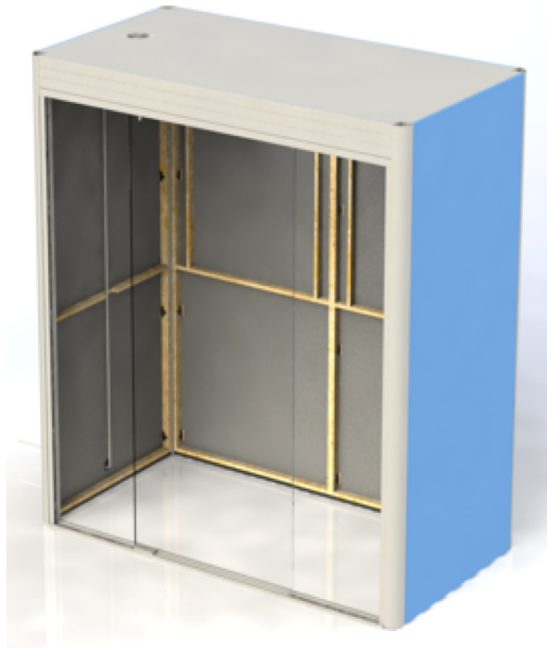

- A. To finish the ceiling lift the white ceiling cover into position with the air inlet towards the left of the booth.
- B. Attach the fan cover over the air inlet and secure with 4 - #8 x 3/4" wood screws from the hardware kit.

## Step 9



- A. Install the internal rear fabric panels. Both full size panels are interchangeable so it does not matter which you use for each side wall. Note, if you have an extension cord that needs to connect to a TV, please pull the cord end through the grommet before installing the panel. See instructions at the end of this document for optional TV Mount instructions.
- B. Lift the panel into the booth, line up with frame & push into place making contact with the 4 clips on each side and 2 along the top. Repeat for other side.

## Step 10



- A. Install the side fabric panels. Both full size panels are interchangeable so it does not matter which you use for each side wall. Note, if you have an extension cord that needs to connect to a powered sofa, please pull the cord end through the grommet before installing the panel.
- B. Lift the panel into the booth, line up with frame & push into place making contact with the 4 clips on each side and 2 on the top. Repeat for other side.

## Step 11



- A. Hang the glass door panel. Adjust the top hinge to make sure the glass sits even in the frame.
- B. Install the door handle from the hardware kit.
- C. With the door in a closed position make sure the door is square and the gaps are even. The side glass panels may need to be move to even the gaps. Simply remove the glazing seal you installed in Step 6, adjust the glass position and re-install the glazing seal.
- D. Test the door closure several time to makes the mechanism is working as expected.
- E. Install hinge covers.
- F. Install "V" seal door gasket sweeps on both glass panels facing the door. Wipe glass edge with alcohol wipe before adhering. See picture below.

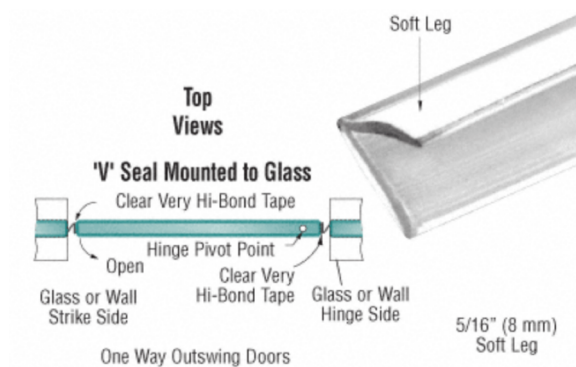

## Step 12



- A. Test the door again to make sure the closing speed is working properly. If the door needs adjustment, see instructions at the end of this document.
- B. Give the booth a final clean on the all painted profiles, glass & work surface.
- C. Remove the film covering that is protecting the threshold.
- D. Use a lint roller on the fabric panels to remove any handling marks.
- E. Adjust the motion sensor as follows:
  - i. Press and hold the button on the side for 5 seconds until the red LED illuminates. Then press:
    - a. Twice for 10 minutes
    - b. Three times for 30 minutes
    - c. Four times for 60 minutes
  - ii. After the countdown timer is set, the LED will flash the same number of times the button was pressed to confirm the new timer setting.
- F. Secure the motion sensor to the interior top corner by using the double stick tape provided on the back of the sensor.
- G. Install any optional furniture. Installation instructions are supplied at the end of this document.

## OPTIONAL PEDESTAL TABLE

### Tools needed for assembly:

- #2 Phillips Screwdriver/Bit

### Hardware/Accessory Kit:

- Qty Depends on Size of Table - #10 x 1" Wood Screws

### Before you start:

1. Read instructions and check that all parts are accounted for before you start building.
2. Begin assembly as close to final product location as possible.
3. Additional assembly instructions may be required depending on specification of product ordered.
4. Read all Operating & Safety instructions before using this Oasis Berco furnishing.

# Step 1

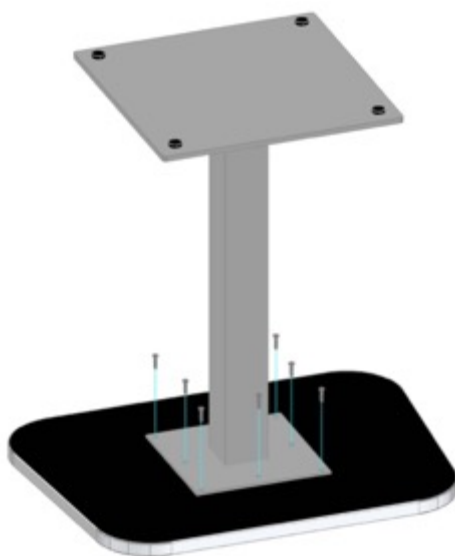

- A. If applicable, install electrical following manufacturer directions provided.
- B. Attach top to legs using #10 x 1" Wood Screws in pre-drilled locations in the table top.
- C. **Note: There may be more than leg to install based on the size of the table.**
- D. If applicable, connect electrical outlet to extension cord coming out of the wall grommet. Push extra cord into the wall through the grommet opening.

## OPTIONAL SOFA

### Tools needed for assembly:

- None

### Hardware/Accessory Kit:

- None

### Before you start:

1. Read instructions and check that all parts are accounted for before you start building.
2. Begin assembly as close to final product location as possible.
3. Additional assembly instructions may be required depending on specification of product ordered.
4. Read all Operating & Safety instructions before using this Oasis Berco furnishing.

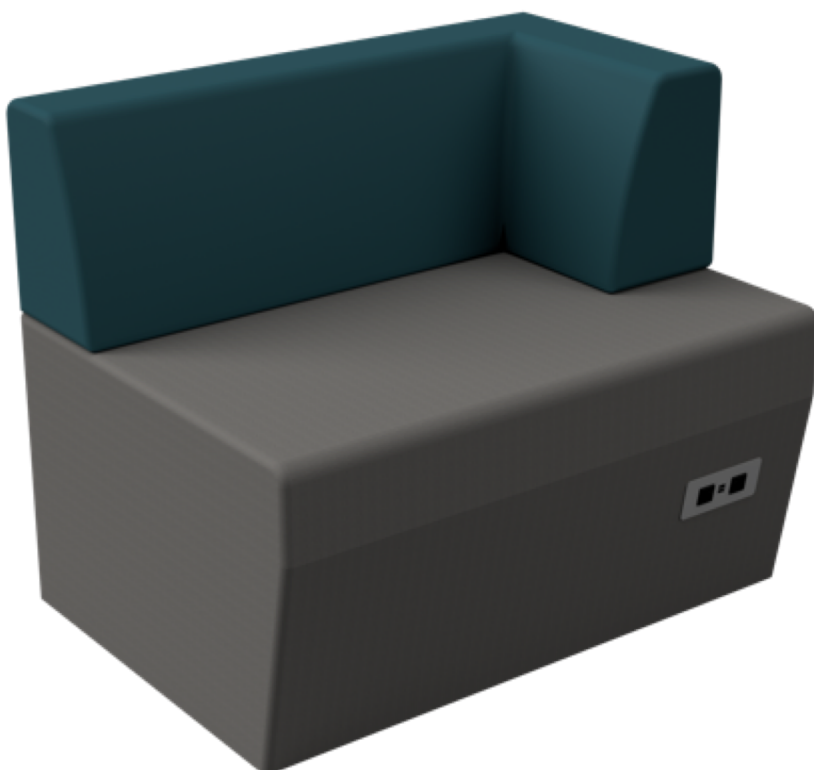

- A. After unit is assembled place booth on proper side. If sofa has one arm rest, it goes to the rear of the unit.
- B. If sofa has electrical, plug into the extension cord coming out of the wall panel. Push extra cord into the wall or under the sofa.
- C. Slide the sofa against the wall panel.

## OPTIONAL TV WALL MOUNT

### Tools needed for assembly:

- See instructions in TV Wall Mount box

### Hardware/Accessory Kit:

- All hardware necessary will be included in TV Wall Mount box

### Before you start:

1. Read instructions and check that all parts are accounted for before you start building.
2. Begin assembly as close to final product location as possible.
3. Additional assembly instructions may be required depending on specification of product ordered.
4. Read all Operating & Safety instructions before using this Oasis Berco furnishing.



- A. Image above is representative. Actual bracket may vary slightly.
- B. Designed for TV's 32" to 55"
- C. Max weight limit (including bracket) is 99 lbs.
- D. Install per instructions provided with TV Wall Mount
- E. Route all electrical through grommets to connect to TV.
- F. **MAKE SURE THAT THE BRACKET IS SCREWED SECURELY INTO WALL BLOCKING TO AVOID THE RISK OF THE TV FALLING**

## DOOR CLOSING SPEED ADJUSTMENT

### DOOR ADJUSTMENT

8. Adjust the closing speed. (Fig. 10)

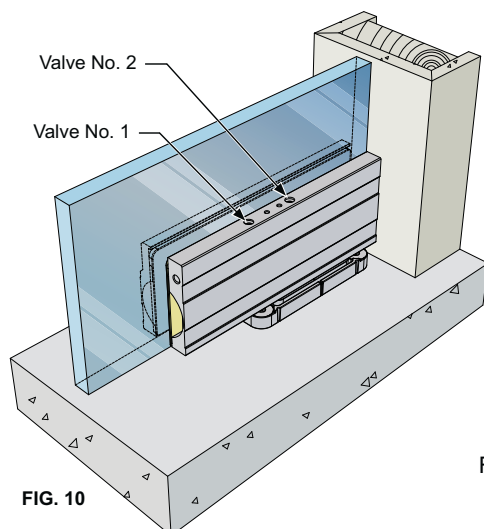

FIG. 10

Adjustment of closing speed:

- Two regulating valves (No. 1) and (No. 2)

- ↻ Decrease closing speed

- ↻ Increase closing speed

- Valve (No. 1): Control closing range 170° to 15°

- Valve (No. 2): Control closing range 15° to 0°

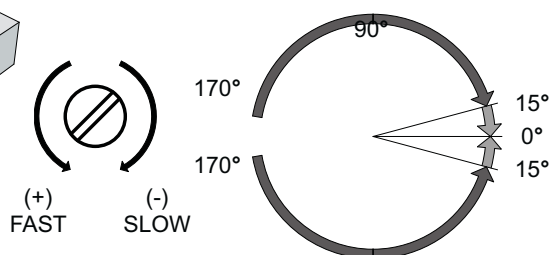



## ELECTRICAL TROUBLESHOOTING

### Installation Instructions

### Programming the Countdown Timer

**Step 1**

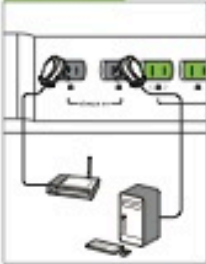

Plug in devices that require continuous power into the always-on outlets (e.g., modem, CPU).

**Step 2**

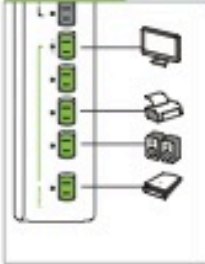

Plug peripheral electronics into the outlets on the power strip labeled "switched".

**Step 3**

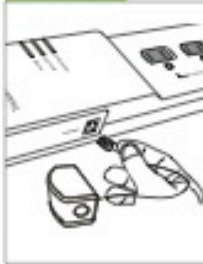

Plug the SensorClick motion sensor into the port on the side of the power strip that looks like a phone jack and is marked "sensor".

**Step 4**



Mount the motion sensor to a flat surface (e.g., under the desk) aiming at the area you wish to detect movement.

**Step 5**



Plug the power strip into a grounded outlet receptacle. The ground and surge lights on the power strip will illuminate indicating that power strip is properly grounded, and that surge protection is active.

**Important:** The product must only be plugged into a grounded outlet receptacle. All connected electronics should be plugged directly into the product. Use of an extension cord, adaptor, or any power strip in conjunction with the Product will void all warranties.

The SensorClick motion sensor has a configurable countdown timer that has a default setting of 30 minutes.

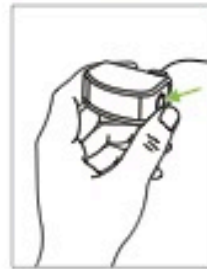

To configure the countdown timer, press and hold the button on the side of the SensorClick motion sensor for 5 seconds until the red LED illuminates. Then press:

- Twice for 10 minutes
- Three times for 30 minutes
- Four times for 60 minutes

After the countdown timer is set, the LED will flash the same number of times the button was pressed to confirm the new timer setting.

### Troubleshooting

- 1 There is no power supplied to any of the outlets.**  
Ensure that the circuit breaker switch on the top of the power strip is not set to off. If so, flip the switch to reset the circuit breaker.
- 1 There is no power supplied to the switched outlets.**  
The SensorClick motion sensor must be connected to the power strip, and motion must be detected to turn on the switched outlets.  
Alternatively, press the button on the motion sensor to manually turn on the switched outlets.
- 1 The SensorClick motion sensor is blinking.**  
This is a notification that no motion has been detected within the countdown timer period, and that the electronics plugged into the switched outlets will soon shut off.  
The LED on the motion sensor will also flash each time motion is detected.
- 1 The electronics plugged into the switched outlets keep switching off.**  
The power strip shuts off the electronics plugged into the switched outlets after 10/30/60 minutes if no motion is detected by the motion sensor. Ensure that the motion sensor is placed in a proper location and can detect movement. The countdown timer will reset for another 10/30/60 minutes each time motion is detected.