

BOOTHS (Duo, Small Team & Large Team)
**SAFETY AND INSTALLATION
INSTRUCTIONS**

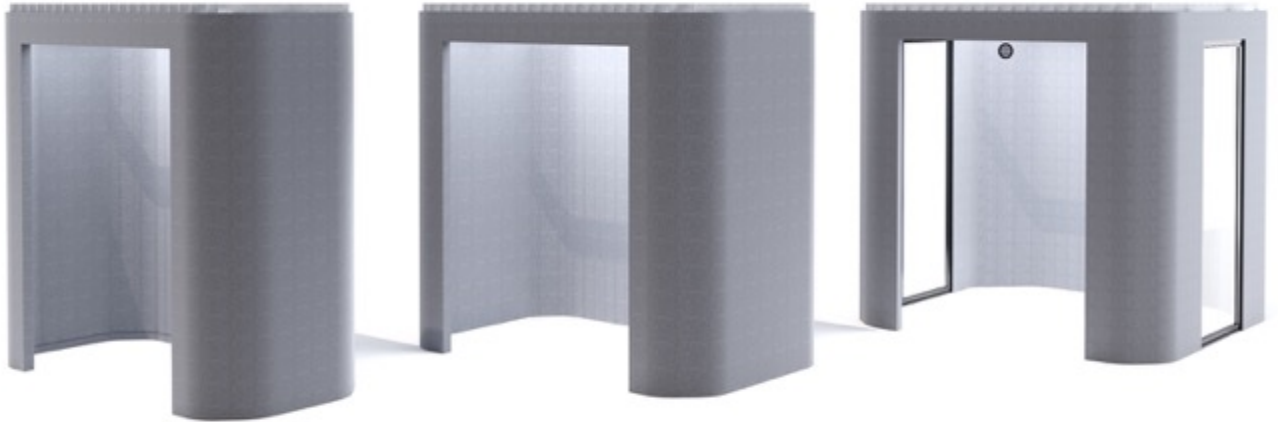

Oasis Berco Installation, Operating & Safety Instructions

Linear & Soft Pod, Booth and Hub

- All Oasis Berco products are intended for commercial use.
- Please note that specific installation drawings and instructions are provided at the end of this document.
- **WARNING** Risk of injury – Maximum Load on Table Surface is 200 pounds evenly distributed
- **DRY LOCATIONS ONLY**

IMPORTANT SAFETY INSTRUCTIONS

When using an electrical furnishing, basic precautions should always be followed, including the following: Read all instructions before using this Oasis Berco furnishing.

DANGER – To reduce the risk of electric shock:

1. Always unplug this furnishing from the electrical outlet before cleaning.

WARNING – To reduce the risk of burns, fire, electric shock, or injury to persons:

1. Unplug from outlet before putting on or taking off parts.
2. Close supervision is necessary when this furnishing is used by, or near children, invalids, or disabled persons.
3. Use this furnishing only for its intended use as described in these instructions. Do not use attachments not recommended by the manufacturer.
4. Never operate this furnishing if it has a damaged cord or plug, if it is not working properly, if it has been dropped or damaged, or dropped into water. Return the furnishing to a service center for examination and repair.
5. Keep the cord away from heated surfaces.
6. Never operate the furnishing with the air openings blocked. Keep the air openings free of lint, hair, and the like.
7. Never drop or insert any object into any opening.
8. Do not use outdoors.
9. Do not operate where aerosol (spray) products are being used or where oxygen is being administered.
10. **WARNING: Risk of Electric Shock** – Connect this furnishing to a properly grounded outlet only. See Grounding Instructions below.
11. For loading always put heavier items at the bottom and not near the top in order to help prevent the possibility of the furnishing tipping over.
12. **WARNING** Risk of injury – Maximum Load on Table Work Surface is 200 pounds evenly distributed.

SAVE THESE INSTRUCTIONS

GROUNDING INSTRUCTIONS

This product is for use on a nominal 120-volt circuit and has a grounding plug that looks like the plug illustrated in the sketch below. Make sure that the product is connected to an outlet having the same configuration as the plug. No adapter should be used with this product.

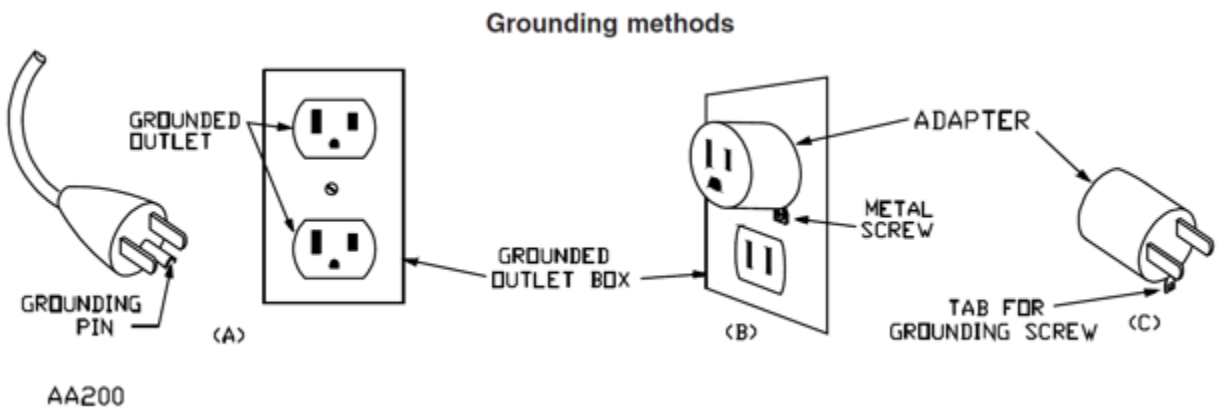

Tools needed for assembly:

- #2 Phillips Screwdriver/Bit

Hardware/Accessory Kit:

- Qty Depends on Booth Size - #8 x 5/8" Wood Screws
- 28 - 1/4" x 20 x 2" Bolt
- 28 - 1/4" Fender Washer

Before you start:

1. Read instructions and check that all parts are accounted for before you start building.
2. Begin assembly as close to final product location as possible.
3. Additional assembly instructions may be required depending on specification of product ordered.
4. Read all Operating & Safety instructions before using this Oasis Berco furnishing.

Step 1



- A. The power unit can be supplied from either rear corner. Position the rear corner with the cable access port (exterior grommet hole) closest to the power source.
- B. Start the build with the rear straight media wall and one rear corner section.
- C. Attach the straight wall section to the curved section with 4 - 1/4" x 20 x 2" bolts and fender washers. These will screw into the threaded inserts in the corner section.
- D. Make sure the panels line up along the inside, outside and top before fully tightening bolts.



Step 2

- A. Attach the opposite rear corner with 4 - 1/4" x 20 x 2" bolts and fender washers. These will screw from the straight section into the threaded inserts in the corner section.
- B. Make sure the panels line up along the inside, outside and top before fully tightening bolts.
- C. Make sure the booth is in the correct position and the power access is on the correct side.



Step 3

- A. Attach a straight side panel to the left side of the booth corner with 4 - 1/4" x 20 x 2" bolts and fender washers. These will screw from the straight section into the threaded inserts in the corner section.
- B. Make sure the panels line up along the inside, outside and top before fully tightening bolts.
- C. Repeat the same process for the straight side panel on the right side.
- D. If your floor is not level, you can adjust the height adjustable glides located in the base rails. These will be adjusted from underneath each wall section. Carefully tilt the booth to reach the glides and twist to adjust the height. Repeat as necessary in order to level booth.

Step 4



- A. Attach the front left corner with 4 - 1/4" x 20 x 2" bolts and fender washers. These will screw from the straight section into the threaded inserts in the corner section. NOTE THE LEFT AND RIGHT FRONT CORNERS ARE NOT INTERCHANGEABLE.
- B. Make sure the panels line up along the inside, outside and top before fully tightening bolts.
- C. Repeat the process for the front right corner.

Step 5



- A. Attach the header with 4 - 1/4" x 20 x 2" bolts and fender washers. These will screw from the header section into the threaded inserts in the corner section.
- B. Make sure the panels line up along the inside, outside and top before fully tightening bolts.
- C. Adjust levelling glides under the front corners if needed to level the booth.



Step 6

- A. Attach the door header internal panel. Align the clips and press into place.



Step 7

- A. Complete the doorway installation with three trim sections.
- B. First, install the top section by aligning the barbed fasteners with the holes in the header and pressing into place.
- C. Install the left and right vertical sections in the same manner.

Step 8



- A. Install the louvre ceiling. If you have a fully enclosed ceiling, reference optional instructions at the end of this document and then move on to Step 10.
- B. On the Large Team Booth, the louvre ceiling can be installed with the louvres running side/side or front/back. The image above is showing the side/side installation.
- C. Mount the side supports along the top edge of the structure. There will be two corner and one straight section for each side. The metal fold sits on the inside of the top lip. Secure with #8 x 5/8" wood screws. See detail drawing below for further clarification.
- D. Lay the lighting channels in position but do not screw in place. Position the channel with the motion sensor on the side of the booth closest to the corner with the power supply.
- E. Route the cords for the lighting and motion sensor down through the corner with the power supply. You will connect the power later in the installation.
- F. *Note: if you are installing a Small Team Booth or Duo Booth, there will only be one lighting rail that will run from side to side and the louvres can only run front to back. See louvre detail later in this document.*

Step 9



- A. The louvres have various sizes based on the size booth and location of the louvre. See detailed louvre instructions on the following pages.
- B. Install the louvres per the detailed plans. Always start from one side, finish that entire side and then move to the middle (if applicable) and then complete the other side.
- C. Once all louvres are installed secure the ends of the lighting channels with #8 x 5/8" screws.
- D. Your ceiling installation is now complete.

LARGE TEAM BOOTH – LOUVRE DETAIL

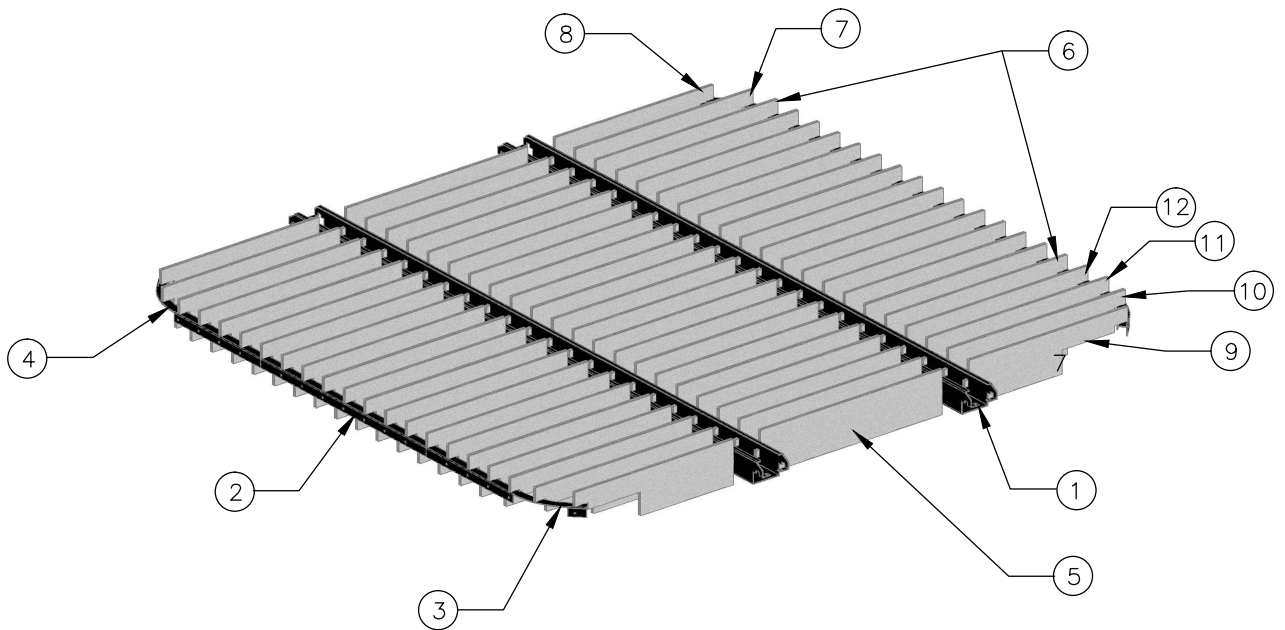

ITEM NO.	Description	Drawing No	Part no	QTY.
1	Dasis Soft Lighting Channel LTB	DBD_0052		2
2	Louver Support Straight 800	DBD_0054		2
3	Louver Corner Support LH	DBD_0055		2
4	Louver Corner Support RH	DBD_0056		2
5	Dasis Soft Ceiling Louvre (Centre)	DBD_0051		21
6	Dasis Soft Ceiling Louvre - Standard	DBD_0050		30
7	Dasis Soft Ceiling Louvre - C2	DBD_0048		2
8	Dasis Soft Ceiling Louvre - C1	DBD_0049		2
9	Dasis Soft Ceiling Louvre - SC1	DBD_0047		2
10	Dasis Soft Ceiling Louvre - SC2	DBD_0046		2
11	Dasis Soft Ceiling Louvre - SC3	DBD_0045		2
12	Dasis Soft Ceiling Louvre - SC4	DBD_0044		2

SMALL TEAM BOOTH – LOUVRE DETAIL

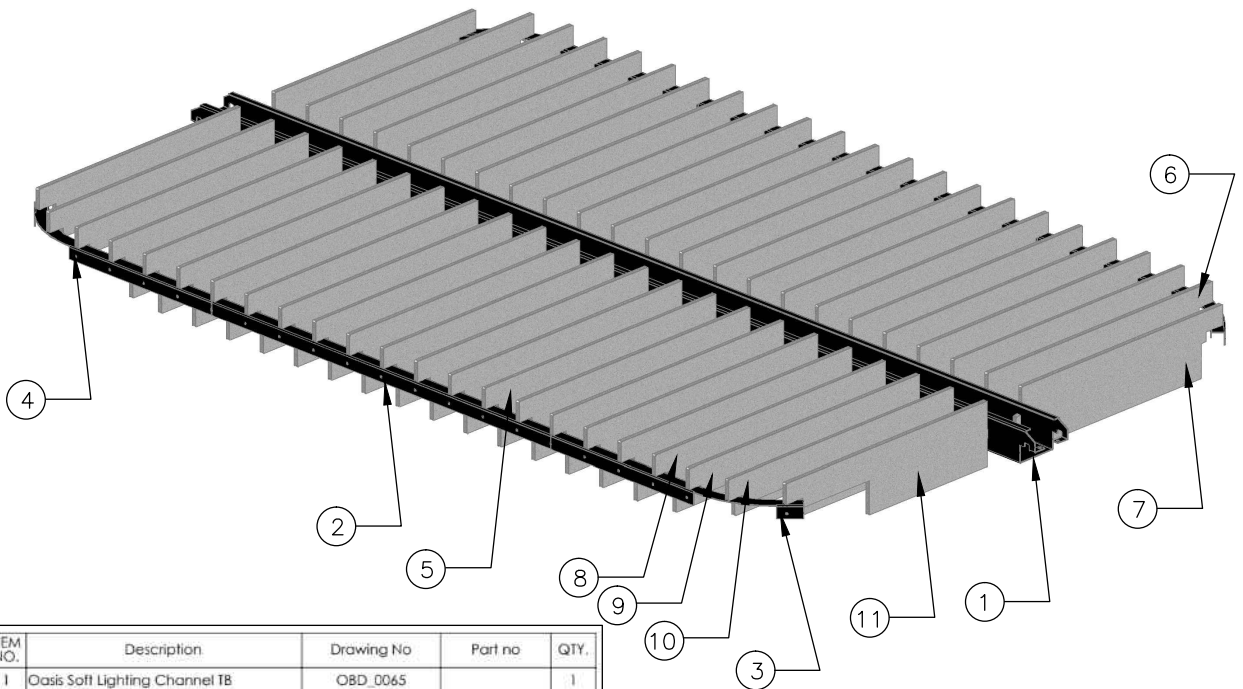

ITEM NO.	Description	Drawing No	Part no	QTY.
1	Oasis Soft Lighting Channel TB	OBD_0065		1
2	Louver Support Straight 1000	OBD_0066		2
3	Louver Corner Support LH	OBD_0055		2
4	Louver Corner Support RH	OBD_0056		2
5	Oasis Soft Ceiling Louvre - Standard	OBD_0050		34
6	Oasis Soft Ceiling Louvre - C2	OBD_0048		2
7	Oasis Soft Ceiling Louvre - C1	OBD_0049		2
8	Oasis Soft Ceiling Louvre - SC4	OBD_0044		2
9	Oasis Soft Ceiling Louvre - SC3	OBD_0045		2
10	Oasis Soft Ceiling Louvre - SC2	OBD_0046		2
11	Oasis Soft Ceiling Louvre - SC1	OBD_0047		2

DUO BOOTH – LOUVRE DETAIL

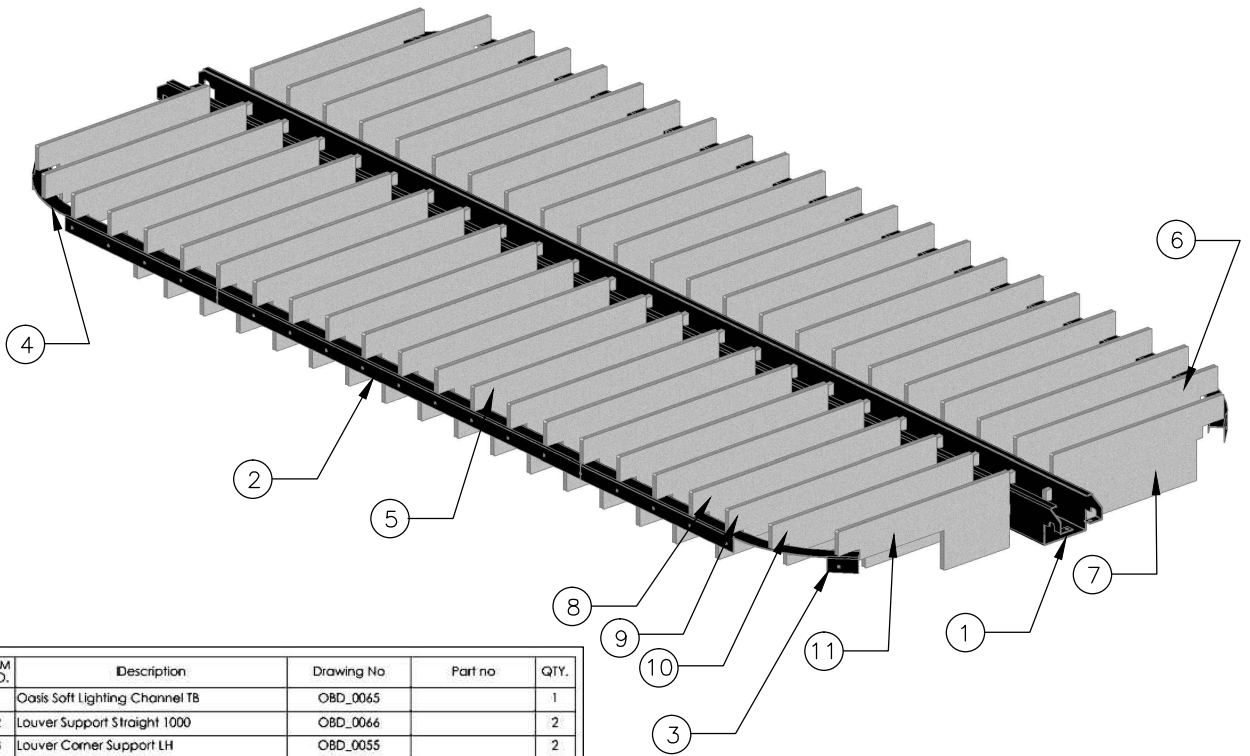

ITEM NO.	Description	Drawing No	Part no	QTY.
1	Oasis Soft Lighting Channel TB	OBD_0065		1
2	Louvre Support Straight 1000	OBD_0066		2
3	Louvre Corner Support LH	OBD_0055		2
4	Louvre Corner Support RH	OBD_0056		2
5	Oasis Soft Ceiling Louvre - Duo Standard	OBD_0077		34
6	Oasis Soft Ceiling Louvre - Duo C2	OBD_0079		2
7	Oasis Soft Ceiling Louvre - Duo C1	OBD_0078		2
8	Oasis Soft Ceiling Louvre - Duo SC4	OBD_0135		2
9	Oasis Soft Ceiling Louvre - Duo SC3	OBD_0136		2
10	Oasis Soft Ceiling Louvre - Duo SC2	OBD_0137		2
11	Oasis Soft Ceiling Louvre - Duo SC1	OBD_0138		2

Step 10



- A. Attach the internal cover panels to the side walls. If there are glass side walls, there will be small side wall panels to install. Align the panels with the clips and push into place. The side panels are acoustic so they will have acoustic panels on the inside.
- B. Attach the corner panel without power. Align the panel with the clips and push into place.

Step 11



- A. Before installing the corner panel with the electronics, all connections will have to be made. For troubleshooting, see "Electrical Troubleshooting" section at the end of this document.
- B. Route the cord that will be plugged into the electrical outlet through the bottom grommet hole and out the back of the booth. DO NOT YET PLUG THE END IN.
- C. Connect the power cord from the ceiling lighting to one of the outlets on the power strip labelled "switched".
- D. Connect the motion sensor cord from the ceiling to the port on the side of the power strip labelled "sensor".
- E. If you have optional power required for a TV or outlets, those extension cords should be plugged into the outlets on the power strip labelled "always on". Route those extension cords through the corner panel into the media wall section so they can be pulled through the grommets in the media wall.
- F. Connect the power and make sure the light turns off/on via the sensor (the light intensity can be changed by adjusting the dials on the ceiling panel).
 - i. If the light does not work, first check all connections on the wall panel and ceiling.
 - ii. Reset the motion sensor (See Step 12, B).
 - iii. See Electrical Troubleshoot section at the end of this document.
 - iv. If all connections are secure, please contact Oasis Berco at 888-772-4788 and ask for Dave Dunn or James Holborow in Engineering.
- G. Install the corner electronics panel by lining up the clips and pushing into place.
- H. Route any necessary cords through the media wall. Install the media wall panel by lining up the clips and pushing into place.

Step 12



- A. Use a lint roller on the fabric panels to remove any handling marks.
- B. Adjust the motion sensor as follows:
 - i. Press and hold the button on the side for 5 seconds until the red LED illuminates. Then press:
 - a. Twice for 10 minutes
 - b. Three times for 30 minutes
 - c. Four times for 60 minutes
 - ii. After the countdown timer is set, the LED will flash the same number of times the button was pressed to confirm the new timer setting.
- C. Secure the motion sensor to the rear portion of the light panel by using the double stick tape provided on the back of the sensor.
- D. Install any optional furniture/accessories – see the end of this document for installation instructions

OPTIONAL WALL MOUNTED PEDESTAL TABLE

Tools needed for assembly:

- #2 Phillips Screwdriver/Bit

Hardware/Accessory Kit:

- Qty Depends on Size of Table - #10 x 1" Wood Screws

Before you start:

1. Read instructions and check that all parts are accounted for before you start building.
2. Begin assembly as close to final product location as possible.
3. Additional assembly instructions may be required depending on specification of product ordered.
4. Read all Operating & Safety instructions before using this Oasis Berco furnishing.

Step 1

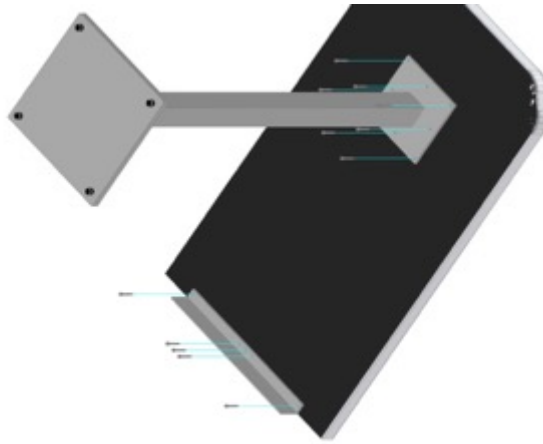

- A. If applicable, install electrical following manufacturer directions provided.
- B. Attach top to legs using #10 x 1" Wood Screws in pre-drilled locations in the table top.
- C. Attach wall bracket to top using #10 x 1" Wood Screws in pre-drilled locations in the table top.

Step 2



- A. If applicable, connect electrical outlet to extension cord coming out of the wall grommet. Push extra cord into the wall through the grommet opening.
- B. Secure table to wall using #10 x 1" Wood Screws
- C. **MAKE SURE TO SCREW SECURELY INTO WALL BLOCKING**

OPTIONAL PEDESTAL TABLE

Tools needed for assembly:

- #2 Phillips Screwdriver/Bit

Hardware/Accessory Kit:

- Qty Depends on Size of Table - #10 x 1" Wood Screws

Before you start:

1. Read instructions and check that all parts are accounted for before you start building.
2. Begin assembly as close to final product location as possible.
3. Additional assembly instructions may be required depending on specification of product ordered.
4. Read all Operating & Safety instructions before using this Oasis Berco furnishing.

Step 1

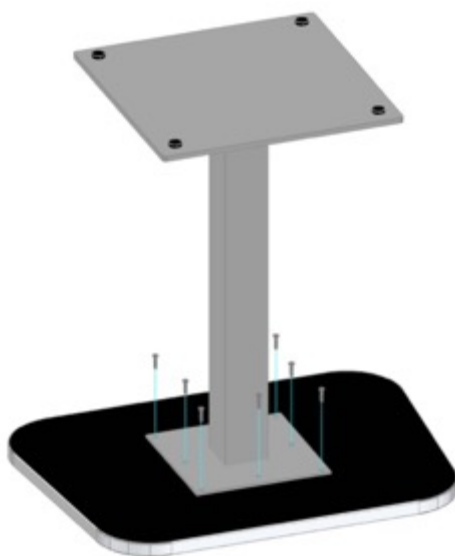

- A. If applicable, install electrical following manufacturer directions provided.
- B. Attach top to legs using #10 x 1" Wood Screws in pre-drilled locations in the table top.
- C. **Note: There may be more than leg to install based on the size of the table.**
- D. If applicable, connect electrical outlet to extension cord coming out of the wall grommet. Push extra cord into the wall through the grommet opening.

OPTIONAL WALL MOUNTED WOOD FRAME TABLE**Tools needed for assembly:**

- #2 Phillips Screwdriver/Bit

Hardware/Accessory Kit:

- Qty Depends on Size of Table - #8 x 3 1/2" Wood Screws
- 4 - #8 x 2 1/2" Wood Screws

Before you start:

1. Read instructions and check that all parts are accounted for before you start building.
2. Begin assembly as close to final product location as possible.
3. Additional assembly instructions may be required depending on specification of product ordered.
4. Read all Operating & Safety instructions before using this Oasis Berco furnishing.

Step 1

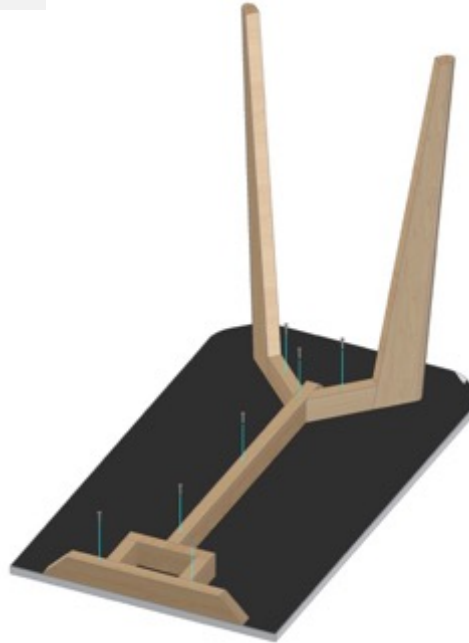

- A. If applicable, install electrical following manufacturer directions provided.
- B. Attach top to legs using #8 x 3 1/2" Wood Screws

Step 2



- A. If applicable, connect electrical outlet to extension cord coming out of the wall grommet. Push extra cord into the wall through the grommet opening.
- B. Secure table to wall using 4 - #8 x 2 1/2" Wood Screws
- C. **MAKE SURE TO SCREW SECURELY INTO WALL BLOCKING**

OPTIONAL SOFA

Tools needed for assembly:

- None

Hardware/Accessory Kit:

- None

Before you start:

1. Read instructions and check that all parts are accounted for before you start building.
2. Begin assembly as close to final product location as possible.
3. Additional assembly instructions may be required depending on specification of product ordered.
4. Read all Operating & Safety instructions before using this Oasis Berco furnishing.

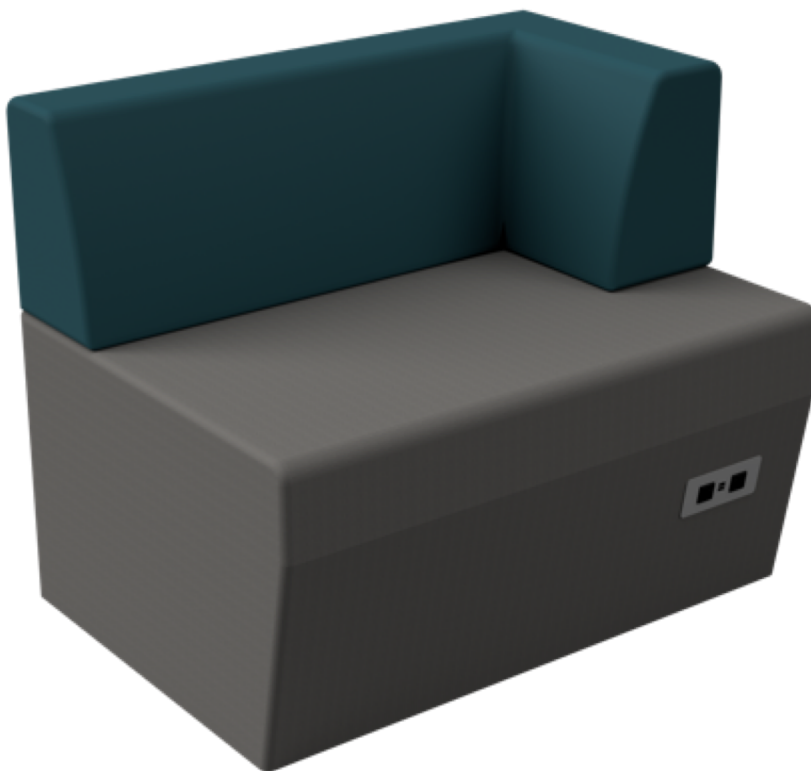

- A. After unit is assembled place booth on proper side. If sofa has one arm rest, it goes to the rear of the unit.
- B. If sofa has electrical, plug into the extension cord coming out of the wall panel. Push extra cord into the wall or under the sofa.
- C. Slide the sofa against the wall panel.

OPTIONAL TV WALL MOUNT

Tools needed for assembly:

- See instructions in TV Wall Mount box

Hardware/Accessory Kit:

- All hardware necessary will be included in TV Wall Mount box

Before you start:

1. Read instructions and check that all parts are accounted for before you start building.
2. Begin assembly as close to final product location as possible.
3. Additional assembly instructions may be required depending on specification of product ordered.
4. Read all Operating & Safety instructions before using this Oasis Berco furnishing.



- A. Image above is representative. Actual bracket may vary slightly.
- B. Designed for TV's 32" to 55"
- C. Max weight limit (including bracket) is 99 lbs.
- D. Install per instructions provided with TV Wall Mount
- E. Route all electrical through grommets to connect to TV.
- F. **MAKE SURE THAT THE BRACKET IS SCREWED SECURELY INTO WALL BLOCKING TO AVOID THE RISK OF THE TV FALLING**

ELECTRICAL TROUBLESHOOTING (Page 1 of 2)

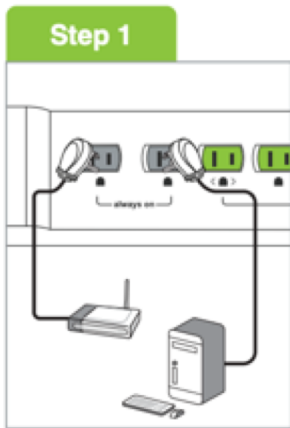

Step 1
Plug in devices that require continuous power into the always-on outlets (e.g., modem, CPU).

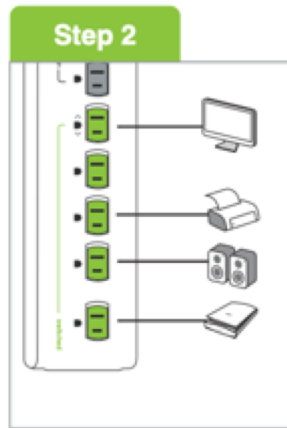

Step 2
Plug peripheral electronics into the outlets on the power strip labeled "switched".

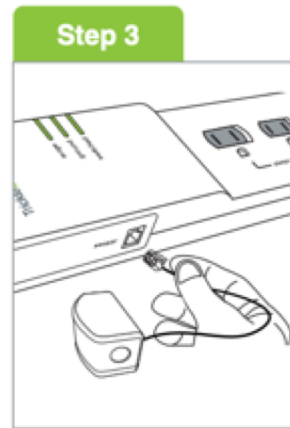

Step 3
Plug the SensorClick motion sensor into the port on the side of the power strip that looks like a phone jack and is marked "sensor".



Step 4
Mount the motion sensor to a flat surface (e.g., under the desk) aiming at the area you wish to detect movement.

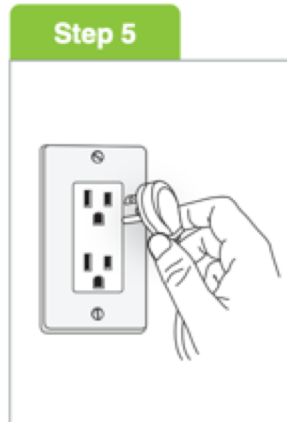

Step 5
Plug the power strip into a grounded outlet receptacle. The ground and surge lights on the power strip will illuminate indicating that the power strip is properly grounded, and that surge protection is active.

! **Important:** The product must only be plugged into a grounded outlet receptacle. All connected electronics should be plugged directly into the product. Use of an extension cord, adaptor, or any power strip in conjunction with the Product will void all warranties.

ELECTRICAL TROUBLESHOOTING (Page 2 of 2)

The SensorClick motion sensor has a configurable countdown timer that has a default setting of 30 minutes.

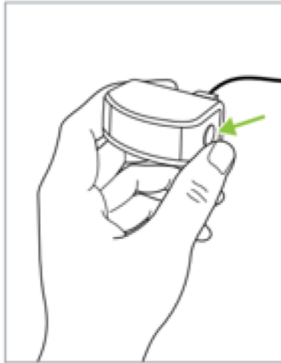

To configure the countdown timer, press and hold the button on the side of the SensorClick motion sensor for 5 seconds until the red LED illuminates. Then press:

- Twice for 10 minutes
- Three times for 30 minutes
- Four times for 60 minutes

After the countdown timer is set, the LED will flash the same number of times the button was pressed to confirm the new timer setting.

Troubleshooting

! There is no power supplied to any of the outlets.

Ensure that the circuit breaker switch on the top of the power strip is not set to off. If so, flip the switch to reset the circuit breaker.

! There is no power supplied to the switched outlets.

The SensorClick motion sensor must be connected to the power strip, and motion must be detected to turn on the switched outlets.

Alternatively, press the button on the motion sensor to manually turn on the switched outlets.

! The SensorClick motion sensor is blinking.

This is a notification that no motion has been detected within the countdown timer period, and that the electronics plugged into the switched outlets will soon shut off.

The LED on the motion sensor will also flash each time motion is detected.

! The electronics plugged into the switched outlets keep switching off.

The power strip shuts off the electronics plugged into the switched outlets after 10/30/60 minutes if no motion is detected by the motion sensor. Ensure that the motion sensor is placed in a proper location and can detect movement. The countdown timer will reset for another 10/30/60 minutes each time motion is detected.